

# analyser

the art of measuring

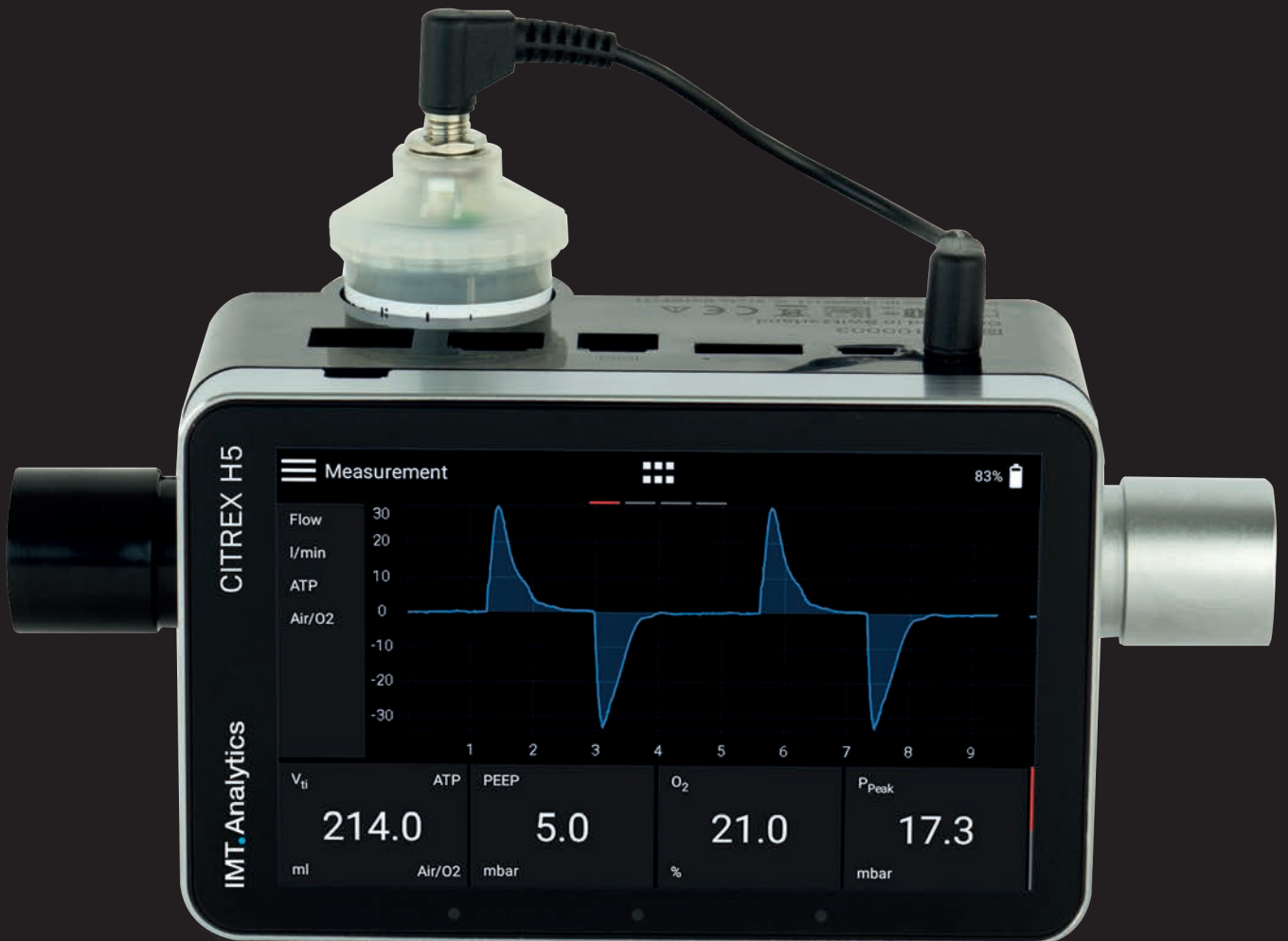

User Manual  
CITREX H5

IMT.Analytics

IMT Analytics AG  
Gewerbstrasse 8  
9470 Buchs (SG)  
Switzerland

[www.imtanalytics.com](http://www.imtanalytics.com)

# Table of Contents

1	Introduction	5
2	Intended use	6
3	Safety instructions	7
3.1	Representation of hazards, cautions and notes	7
3.2	Personnel	7
3.3	Responsibility and guarantee	7
3.4	Service life	7
4	Symbol explanation	8
5	Start-up	9
5.1	Power supply	10
5.2	Mechanical connectors	11
5.2.1	Flow channel	11
5.2.2	Differential pressure	12
5.2.3	High pressure	13
5.2.4	Oxygen sensor	14
5.2.5	Installing the oxygen sensor	14
5.3	Electrical interfaces	16
5.4	Wi-Fi	17
5.5	Change CITREX battery	17
6	Operation	18
6.1	Switching the device on/off	18
6.2	Start screen	18
6.3	User controls	19
6.4	User control gestures	20
6.5	Main menu	21
6.6	Settings	22
6.6.1	Measurements	22
6.7	Numerical readings	23
6.8	Graphical readings	23
6.9	Screen lock	24
6.10	Software update	24
6.11	Applications	25
7	Calibration	26
7.1	Zero point	26
7.2	Oxygen (O <sub>2</sub> ) calibration	27
7.2.1	Calibration with air only	27
7.2.2	Calibration with oxygen and air	27
8	Connecting the device	28
8.1	General measurement setup	28
8.2	Measurement setup for checking ventilators	29
8.3	Measurement setup for gases at high pressure	29
9	Profiles	30

<b>10</b>	<b>Configuration tool</b>	<b>31</b>
10.1	PC minimum requirements	31
10.2	Web server	31
10.2.1	Default	32
10.2.2	Configured	33
10.2.3	DHCP	33
10.2.4	Monitoring option	33
<b>11</b>	<b>Reading measurement data</b>	<b>35</b>
11.1	Reading the data	35
11.2	Cloud service	36
<b>12</b>	<b>Servicing and care</b>	<b>37</b>
12.1	Preventive cleaning and servicing operations	37
12.1.1	During operation	37
12.1.2	Every 4 weeks	37
12.1.3	Every 12 months	37
<b>13</b>	<b>Accessories and spare parts</b>	<b>38</b>
13.1	Accessories table	38
<b>14</b>	<b>Disposal</b>	<b>39</b>
<b>15</b>	<b>Directives and approvals</b>	<b>40</b>
<b>16</b>	<b>Specifications</b>	<b>41</b>
16.1	Measurement parameters	41
16.2	Interface definition	44
16.3	Gas type	44
16.4	Power supply	45
16.5	Battery operation	45
<b>17</b>	<b>Appendix</b>	<b>46</b>
17.1	Principle of flow measurement	46
17.3	Gas standards for flow and volume readings	48
17.4	Conversion factors	49
17.5	List of tables	50
17.6	List of figures	50
17.7	Index	51

# 1 Introduction

**CITREX H5** was developed in order to measure flow and various pressures and thus calculate a large number of ventilation parameters. CITREX H5 is a compact, mobile and easy-to-operate measuring instrument. The integrated oxygen sensor makes it possible for users to determine the oxygen concentration. The instrument is controlled on a 4.3" multi-touch display and it has a large number of different interfaces for data analysis.

The descriptions and instructions in this manual refer to the product CITREX H5. In this User Manual the unit "sL/min" is based on ambient conditions of 0°C and 1013.25 mbar in accordance with DIN 1343.

This documentation applies to the following versions:

CITREX H5 firmware:	4.7.000
CITREX H5 Flow App software:	4.7.000
CITREX H5 hardware:	4.0

In the case of older or newer versions there may be discrepancies in relation to this User Manual.

Subject to technical modifications without notice.



To avoid possible injuries, please read all the safety instructions before you use the product.



The device is not intended for use outside a building.

## 2 Intended use

This product is intended for testing and calibration purposes on medical devices or systems that generate gas flows or gas pressures. That includes ventilators and anaesthetic equipment. The user of the device has received training on how to use medical equipment and can perform repairs, maintenance and servicing on medical devices. The device can be used in hospitals, in clinics, at device manufacturers or at independent service companies that perform repairs or servicing on medical devices.

CITREX H5 is intended for use in a laboratory environment. It may only be used outside the nursing sector. It must not be used directly on patients or devices that are connected to patients. The measuring instrument CITREX H5 is intended for over-the-counter sale.

With CITREX H5 you have the solution for measurements in the following areas:

- Flow
- Volume
- Differential pressure
- High pressure
- Ambient pressure
- Oxygen
- Temperature

In addition, various ventilation parameters can be measured:

- Ventilation rate
- Time
- Ratio
- $T_i/T_{cyc}$
- Tidal volume
- Minute volume
- Peak flow
- Pressure
- Compliance
- Trigger



CITREX H5 is a measuring instrument for checking and calibrating ventilators and anaesthetic equipment. It must not be used for patient monitoring. During patient treatment by the ventilator it is not allowed to connect to CITREX H5.

## 3 Safety instructions

Please read all the safety instructions carefully before you use CITREX H5.

### 3.1 Representation of hazards, cautions and notes

This User Manual uses the representation below to specifically draw attention to residual risks during intended use and emphasise important technical requirements.

Information and/or instructions and prohibitions to prevent damage of any kind, as well as useful tips and information for handling the device, will be indicated by the following icon.



### 3.2 Personnel



Work on and with CITREX H5 may only be performed by persons who have undergone appropriate technical training and have the necessary experience.

### 3.3 Responsibility and guarantee

The manufacturer accepts no responsibility or guarantee and will exempt itself from liability claims accordingly if the operator or any third parties:

- Fail to use the device in accordance with its intended use.
- Disregard the specifications.
- Tamper with the device in any way (conversions, modifications or the like).
- Operate the device with accessories that are not listed in the associated sets of product documentation.



Although the device meets high quality and safety standards and it has been constructed and tested according to the current state of the art, it is not possible to rule out the risk of injuries with serious consequences if the device is used in non-compliance with the intended use (improperly) or is misused.

Therefore please read through this User Manual carefully and keep this documentation in a readily accessible place close to your device.

### 3.4 Service life

The maximum service life of the device has been specified as 10 (ten) years, provided it is handled properly in accordance with this User Manual.

## 4 Symbol explanation

The symbols listed below may appear on the packaging material, on the device rating plate and in the User Manual of the CITREX H5 measuring instrument.













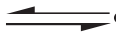
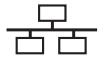





	RS-232 interface
	USB interface
SN BBXXXX	Serial number
	Analog interface
CAN	CAN interface
	Ethernet interface
	On/Off button
	SD card
	Fragile contents
	Keep dry
	Read the User Manual
	The device must not be disposed of in household waste
	The device is CE approved
	Caution: observe the safety instructions in the User Manual
	Reusable packaging
	Manufacturer's specification and date of manufacture
	Keep away from heat
	Temperature range for storage and transport
	CSA monogram with C/US indicator
	California Energy Commission Compliant
	Direct current

Table 1: Symbol explanation



## 5 Start-up

	CITREX H5
	Power supply plug with country-specific adapters
	USB cable
	MicroSD card
	Dust filter
	Inlet pipe
	USB adapter cable
	CITREX carrying case
	Network cable
	Car adapter
	Adapter set

Table 2: Scope of delivery

## 5.1 Power supply

CITREX H5 can be operated from the mains or from the integrated battery.

Power can be supplied via the USB port (Mini B), the Analog interface or the CAN interface on the top of CITREX H5 . Use the power supply unit included to charge the battery or operate the device via the USB port. You will find more information about power supply and how to configure the plugs in section 5.3.

During the charging operation the right-hand status LED is lit orange. As soon as the battery is fully charged the right-hand status LED lights up green.

Please connect the power supply unit included to a voltage of 100 VAC to 240 VAC with a frequency of 50 Hz to 60 Hz.

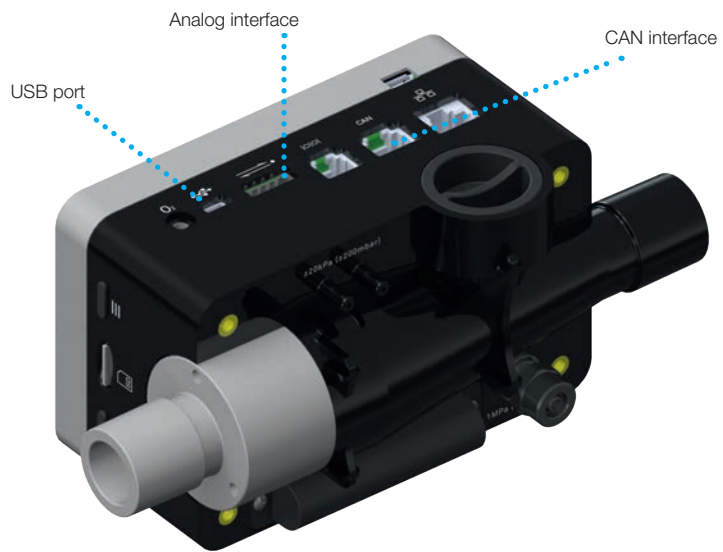

Figure 1: Power supply



Before switching on, make sure the operating voltage of the power supply unit agrees with the local mains voltage. You will find this information on the rating plate on the back of the power supply unit. When operating CITREX H5 via the USB port only use the original power supply unit included!



The device indicates visually and audibly when the battery has to be charged. Please do not store the battery in the depleted state.

**Caution: depletion can damage the battery beyond repair!**

## 5.2 Mechanical connectors

### 5.2.1 Flow channel

The flow channel can be used bidirectionally. The positive flow direction is from left to right, viewed from the front of the device. The measurement of volume, flow, gas temperature, oxygen and channel pressure takes place in the flow channel. The values, and the ventilation parameters calculated from them, can be displayed on the screen. You will find the relevant setting options in section 6: Operation.

Flow (air)	Measuring range	$\pm 300$ sL/min
	Accuracy	$\pm 1.9\%$ of reading or $\pm 0.1$ sL/min
Volume	Measuring range	$\pm 10$ L
	Accuracy	$\pm 2\%$ or $\pm 0.20$ mL ( $> 6$ sL/min)
Temperature	Measuring range	0–50°C
	Accuracy	$\pm 1.75\%$ of reading or 0.5°C
Oxygen	Measuring range	0–100 %
	Accuracy	$\pm 1\%$ O <sub>2</sub>
Pressure in flow channel	Measuring range	-50–150 mbar
	Accuracy	$\pm 0.75\%$ of reading or $\pm 0.1$ mbar



Figure 2: Flow channel

### 5.2.2 Differential pressure

This pressure connector measures the difference in pressure between the two connectors. If only one connector is used for a measurement, pressure measurement takes place at ambient pressure. The measuring range is -200mbar to +200 mbar. Please comply with the maximum permissible pressure at the connector. The sensor values from this pressure sensor can be displayed in the menu with the parameter  $P_{Diff}$ .

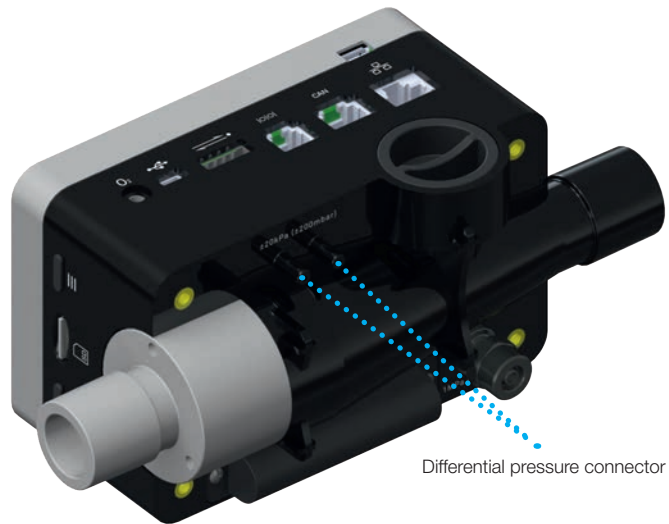

Figure 3: Differential pressure connector

Measuring range  $\pm 200$  mbar  
Accuracy  $\pm 0.75\%$  of reading or  $\pm 0.1$  mbar



Pressures above 1 bar damage the differential pressure sensor beyond repair!

### 5.2.3 High pressure

The high-pressure connector measures the applied pressure up to 10 bar. It is recommended that the differential pressure connector be used for measurements up to 200 mbar. It is up to 100 times more accurate. The sensor values measured can be displayed with the parameter  $P_{\text{high}}$ .

The high-pressure connector can be fitted with a DISS adapter for air and oxygen. You will find the ordering code in section 13 "Accessories and spare parts". The sensor values from this pressure sensor can be displayed in the menu with the parameter " $P_{\text{high}}$ ".



Figure 4: High-pressure connector

Measuring range 0... 10 bar

Accuracy  $\pm 1\%$  of reading or 10 mbar



Pressures above 15 bar damage the high-pressure sensor beyond repair!

### 5.2.4 Oxygen sensor

CITREX H5 can measure the oxygen concentration in the gas flow channel. To do so, an oxygen sensor is screwed into the appropriate port. The oxygen sensor has to be connected to the measuring instrument using the cable included. The following steps explain how to install and replace the oxygen sensor.



Figure 5: Oxygen sensor holder

Measuring range 0–100%  
Accuracy  $\pm 1\% \text{ O}_2$  (absolute)

### 5.2.5 Installing the oxygen sensor

1. Remove the protective cap from the sensor port on the device.



Figure 6: Protective cap

2. Screw the oxygen sensor clockwise into the appropriate port. Make sure the sensor seals off the port and there is no leak.

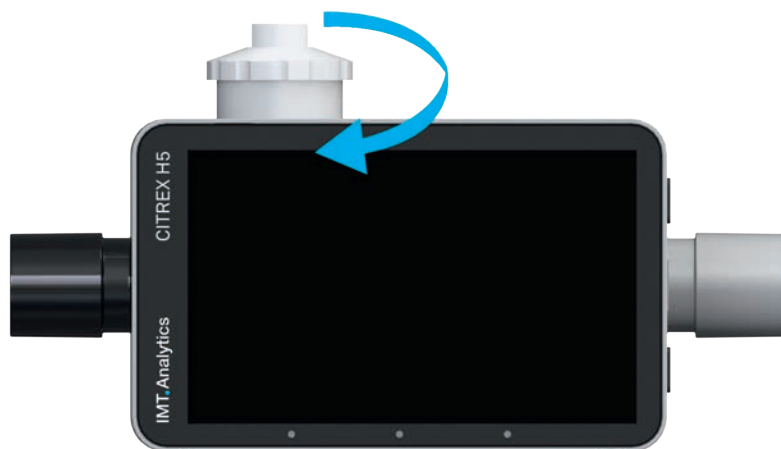

Figure 7: Screwing in the oxygen sensor

3. Connect the cable included to the oxygen sensor by pushing the cable into the hole at the top of the sensor until the cable locks into place. Connect the other end of the cable to CITREX H5 by inserting it into the hole provided, which is labelled "O<sub>2</sub>".

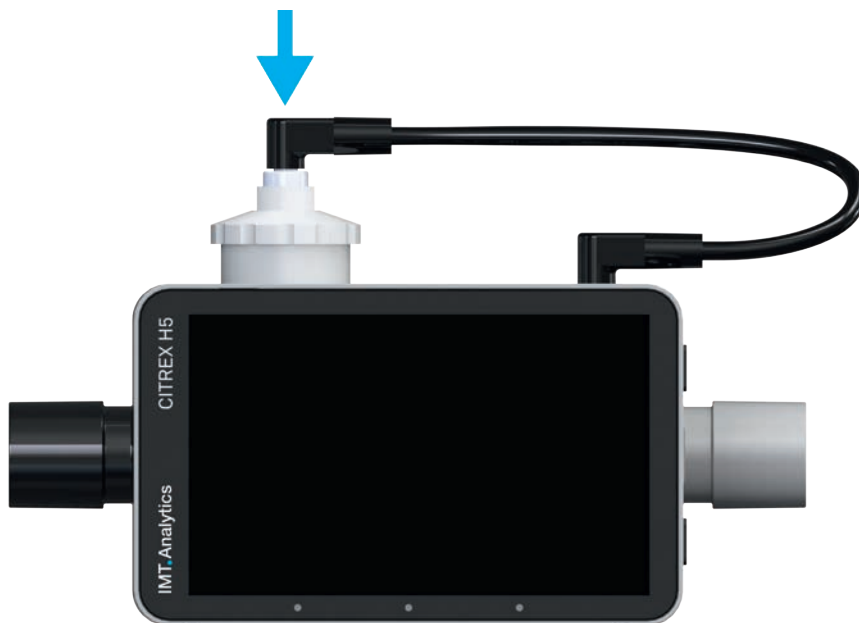

Figure 8: Oxygen sensor cable

4. Perform an oxygen calibration. The calibration procedure is described in section 7. Calibration ensures that the measured values of the new sensor are correct.

5.3 Electrical interfaces

Figure 9 shows the available electrical interfaces of CITREX H5.



Figure 9: Electrical interfaces

1	<b>MicroSD card slot</b>	The firmware of CITREX H5 is stored on the microSD card. It also contains customised configurations and test reports can be saved on the memory card. You will find more information in section 11 "Reading measurement data".
2	<b>O<sub>2</sub> interface</b>	The oxygen sensor is connected to CITREX H5 via the O <sub>2</sub> interface. You will find further information on this in section 5.2.4.
3	<b>USB port</b>	The USB port is used to operate the device from the mains power supply and to charge the device battery but it can also be used as a data interface. It is a "USB Mini-B port". You will find more information in section 11 "Reading measurement data".
4	<b>Analog OUT</b>	The Analog Out port is used for reading analog signals. It is also possible to connect an external trigger. Two ports are reserved for mains operation and charging the device battery. You will find the ordering code for the matching connector in section 13. You will find additional technical information about the port in section 16.2.
5	<b>RS-232</b>	The RS-232 port is used as a data interface. In section 16.2 you will find further information about the interface.
6	<b>CAN</b>	The CAN interface can be used for charging the device battery. You will find information about the port in section 16.2.
7	<b>Ethernet</b>	The Ethernet interface is used to configure the device and it is used as a data interface. You will find more information in section 11 "Reading measurement data".
8	<b>USB Host</b>	This port is used for updating the CITREX H5 software. It is a "USB Micro B port".

Table 3: Description of electrical interfaces



## 5.4 Wi-Fi

CITREX H5 is provided with a Wi-Fi module that makes it possible to connect the device to the internet. With the current software version, software updates can be downloaded via this interface.

The Wi-Fi module can be switched on and off in the "Wi-Fi" submenu, which is located in the "Settings" menu. In the "Wi-Fi" submenu you can select a network to which you want to connect the device. If the network is protected by a password, the latter must be entered before CITREX H5 can be connected to the internet.

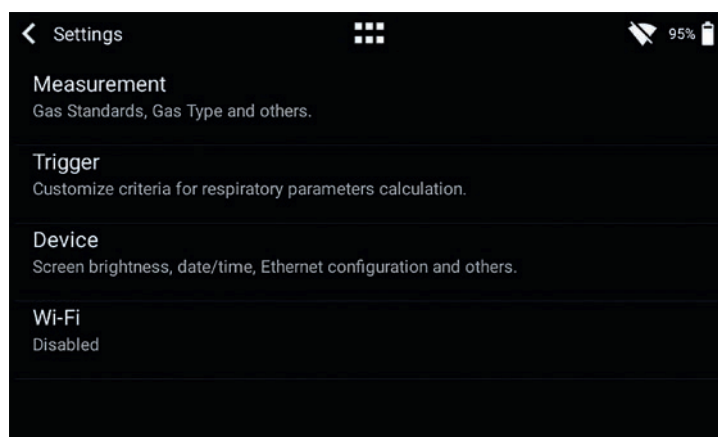

Figure 10: Wi-Fi

## 5.5 Change CITREX battery

The battery of CITREX H5 can be changed by the user. To do so, undo and remove the two screws on the back of the device. Then the battery can be removed and replaced. Check whether the new battery has been inserted properly. For this purpose the terminals must be opposite one another.

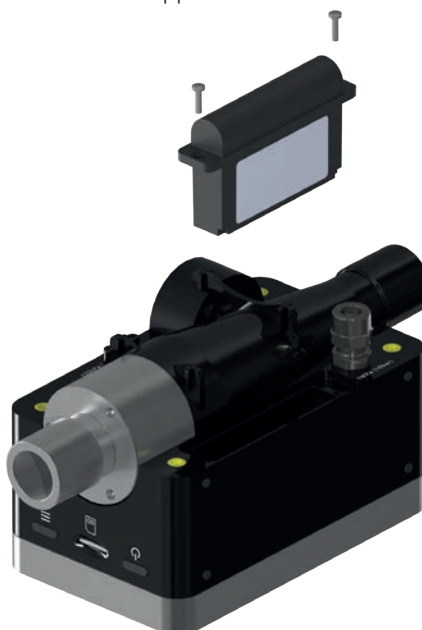

Figure 11: Change battery

## 6 Operation

This section describes how to use the device and what possibilities there are.

### 6.1 Switching the device on/off

The device is switched on and off at the On/Off button. Figure 13 shows where this button is located on the device. To switch CITREX H5 on you must press the On/Off button briefly. You will hear an audible signal. To switch the device off you must press the On/Off button for about 1 second. A shutdown menu appears in which the process has to be acknowledged with a gesture. If the device can no longer be controlled, you have the option of pressing the On/Off button for about 6 seconds. The device is then forced to shut down.

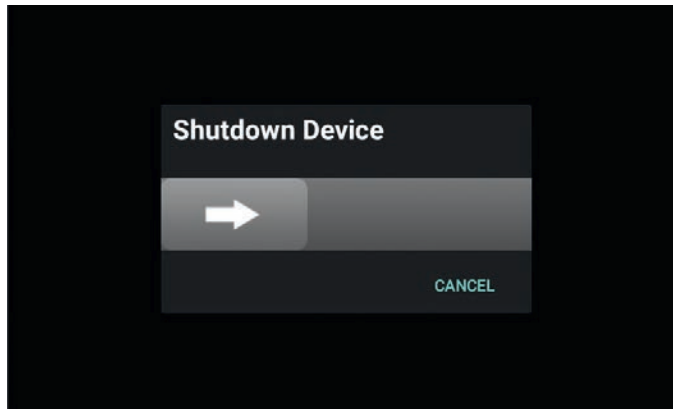

Figure 12: Shutdown menu

### 6.2 Start screen

The start screen appears as soon as the device is switched on. The screen indicates that the device is powering up. After the power-up process the main menu is displayed. The start screen can be seen in figure 12: Start screen.



Figure 13: Start screen

### 6.3 User controls



6

Figure 14: User controls

1	On/Off button
2	Context button; long press: key lock on/off
3	LED 1: Indicates error.
4	LED 2: Lit when the device is switched on.
5	LED 3: Charging process indicator. Lit orange during the charging process and green when the battery is fully charged.

6.4 User control gestures

To be able to operate the multi-touch screen optimally and easily you have various gestures at your disposal.





Gesture	Designation	Action	Function
	Tap	Tap an element once	<ul style="list-style-type: none"> <li>• Increase in readings and measurement curves</li> <li>• Selection of menu items</li> <li>• Perform measurement on the graphical measurement curves</li> </ul>
	Hold down	Press and keep pressed for one second.	<ul style="list-style-type: none"> <li>• Editing readings and curves</li> <li>• Editing files and profiles</li> </ul>
	Swipe	Drag your finger across the screen.	<ul style="list-style-type: none"> <li>• Change views on the measurement screen</li> <li>• Unlock screen</li> <li>• Shut down device</li> </ul>
	Move by dragging	Tap an element, drag it to the position required and let go there.	Move a reading.
	Pinch close or pinch open	Move thumb and index finger together or move them apart.	Zoom in or out on measurement curves.
	Drag with two fingers	Place index finger and middle finger on object and drag.	Moving of measurement curves when the measurement curve is paused.

Table 4: Gestures

## 6.5 Main menu

The main menu is the starting point for operation of CITREX H5. The software version described in this User Manual displays the menu items listed below.

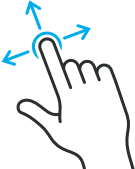
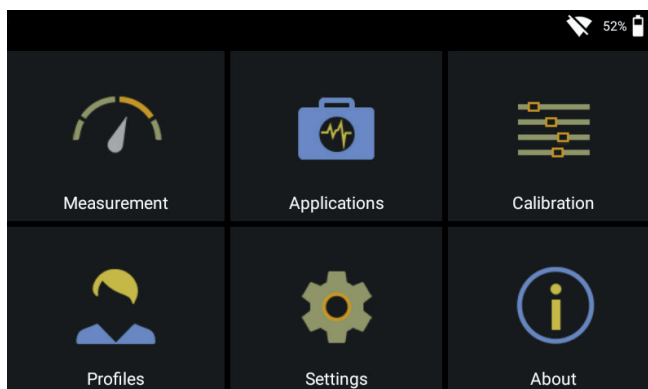

Figure 15: Main menu

<b>Measurement</b>	This is where the measured pressures, flows and ventilation parameters are displayed. There are graphical and numerical methods of representation available. They can be freely configured by the user. You will find more information on this in sections 6.7 and 6.8.
<b>Settings</b>	All device-specific representations are configured in this menu item. The options available are explained in section 6.6.
<b>Calibration</b>	Zero-point calibration and oxygen sensor calibration can be called up with this menu item. You will find details on how to perform calibration in section 7.
<b>Profiles</b>	With CITREX H5 you have the option of creating profiles to suit your particular requirements. You can load, edit and create functions in this menu item. For further information refer to section 9.
<b>Applications</b>	With the menu item Applications you are offered custom applications. If you are in need of such a solution, please contact IMT Analytics at: <a href="mailto:sales@imtanalytics.com">sales@imtanalytics.com</a>
<b>About</b>	This menu item saves user information and device information.

Table 5: Menu items

## 6.6 Settings

In the menu item "Settings" all the settings can be defined.

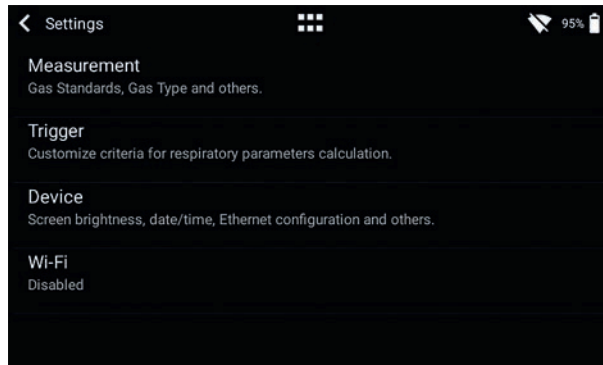

Figure 16: Settings

### 6.6.1 Measurements

Measurement settings contain all the settings to configure measurements. Here you can set the gas standard, gas type, gas humidity and pressure compensation. In addition, this setting also makes it possible to configure the filter type and the ventilation parameter pressure source.

<b>Gas standard</b>	CITREX H5 supports various gas standards. The gas standards are listed in the Appendix under "Gas standards for flow and volume readings"
<b>Gas type</b>	The gas that is to be measured must be set on CITREX H5. O <sub>2</sub> gas mixtures that are referred to as "automatic" are calibrated using the oxygen cell. You will find a complete list of gas types in the section "Gas types".
<b>Gas humidity</b>	Gas humidity must be set under this menu item before measurement. Move the slider until the correct gas humidity has been set.
<b>Pressure compensation</b>	CITREX H5 is pressure compensated. Under this menu item there are two options available. Pressure compensation that takes the pressure sensor in the flow channel or via the high-pressure connector. You will find further information on this in the section "Measurement setup for gases at high pressure".
<b>Filter type</b>	To make the parameters easier to read the readings are filtered. Readings are recorded every 5 ms. The following four options are available: <ul style="list-style-type: none"> <li>• None (raw value)</li> <li>• Low (mean above 240ms)</li> <li>• Medium (mean above 480ms)</li> <li>• High (mean above 960ms)</li> </ul>
<b>Ventilation parameter pressure source</b>	Ventilation parameters require a pressure measurement for calculation. The pressure value from the "P <sub>channel</sub> " sensor is used by default. Optionally the differential pressure sensor "P <sub>diff</sub> " can be selected for automatic calculation.

In the menu sub-item "Measurement" the settings are made for gas type, gas standard, gas humidity and pressure compensation source. CITREX H5 provides three different trigger settings. The associated settings can be found in the sub-item "Trigger". You will find the settings concerning the device in the sub-menu "Device". That contains various adjustment options for the screen, device settings and the various interfaces. In the menu "Other" you can save your personal information.

### 6.7 Numerical readings

You can display all the readings in CITREX H5 numerically or graphically. In Appendix "Measurement parameters and units" you will find an overview of the available readings and parameters. To access edit mode, tap a measurement tile once.

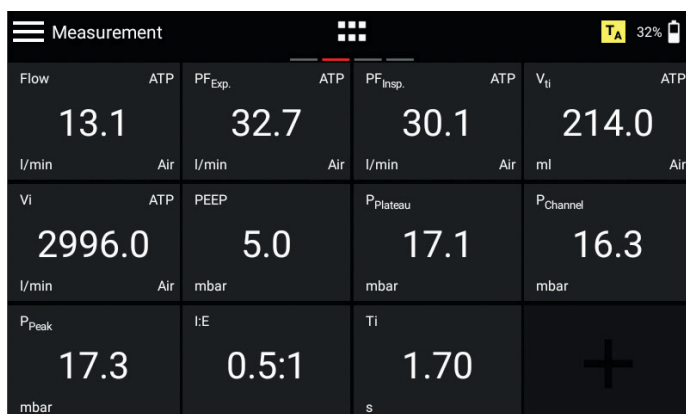

Figure 17: Numerical readings

### 6.8 Graphical readings

Each reading or parameter can be represented by a measurement curve. To edit the value, tap the name of the reading. In the full-screen view you have the option of changing the parameter, the unit of measurement, the gas standard and the gas type. With the pause button you can also freeze the curve and perform measurements on it.

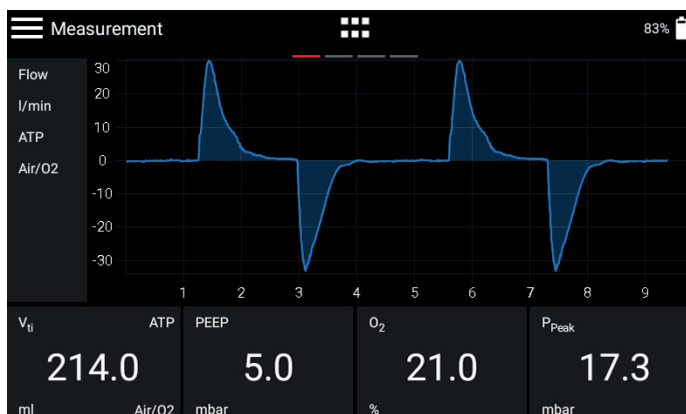

Figure 18: Graphical readings

### 6.9 Screen lock

Press the context button on the side of the device for 2 seconds. The screen shows a message indicating that the screen is locked. To unlock the screen, tap the screen and follow the instructions.

### 6.10 Software update

There are two different ways of providing the device with a new software version. You can provide CITREX H5 with new software by connecting the device to the internet via the Wi-Fi interface. As soon as a new software version is available, a message appears on the screen. Follow the instructions on the screen to install the new software. The second way of installing new software requires a USB stick. Firstly, format a USB memory stick with the FAT32 format. Then copy the installation file to the storage medium and plug the latter into the USB Host port with the USB adapter included. Now start the device and in the sub-menu "About" go to "Software Update". Follow the instructions on the screen.

The installation of new software takes about 10 minutes.



During installation make sure the battery charge is at least 50% or the device is plugged into the power supply with the power supply unit included.



While installation is running, the device must not be switched off!

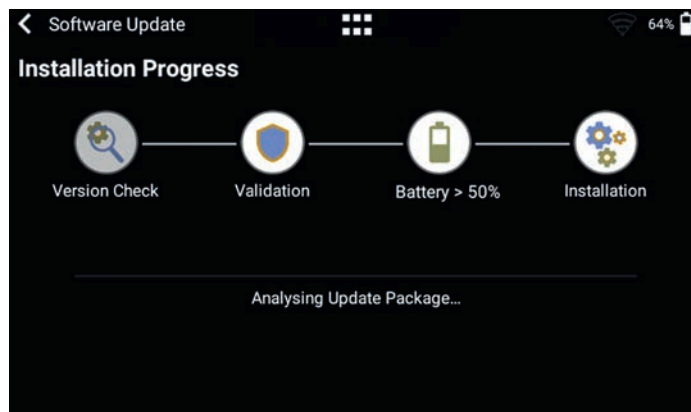

Figure 19: Software update



### 6.11 Applications



Under the menu item "Applications" you can store custom programs and device-specific programs. These are designed to simplify and support the testing of various devices. At the moment you will find two applications on the device, which each create a test report at the end of a test process and save it in the form of a PDF file.

An application with the "Verified" icon indicates that the program has been verified by the manufacturer of the device.

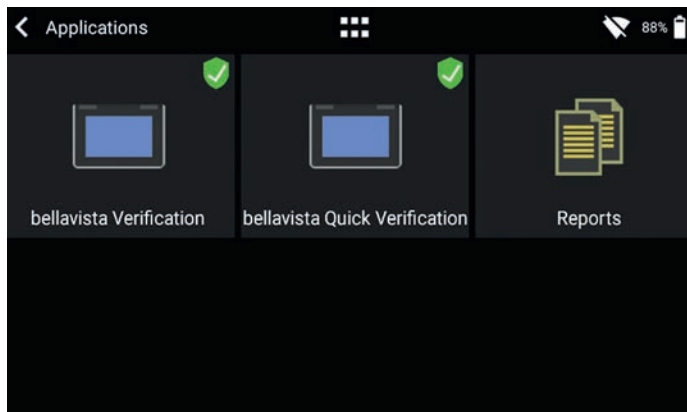

Figure 20: Applications

The menu item "Reports" contains the various test reports in the PDF format. The reports can be viewed, deleted or exported. These functions are located in the context menu at top left. To export the test reports a USB stick with the adapter included must be plugged into the USB Host port on the device.

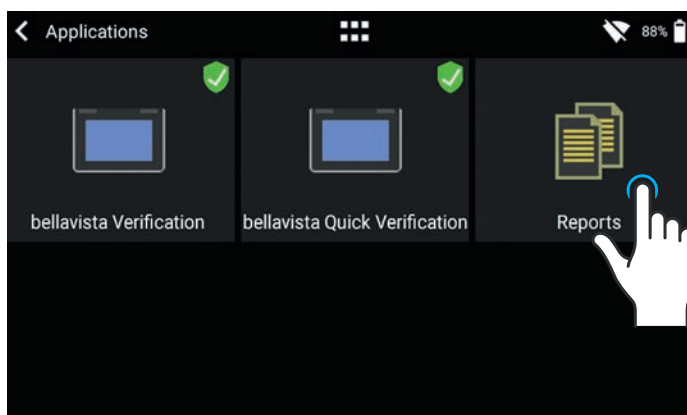

Figure 21: Reports

If you require for your device an application tailored to your particular needs, please contact [sales@imtanalytics.com](mailto:sales@imtanalytics.com).

## 7 Calibration

The various calibrations of CITREX H5 are described in this section. To avoid incorrect measurements you must adhere to the procedures described here.

### 7.1 Zero point

Zero calibration must be performed as soon as CITREX H5 has warmed up. To perform zero calibration you must remove all connected tubes from the device.

In the main menu, tap the "Calibration" icon.

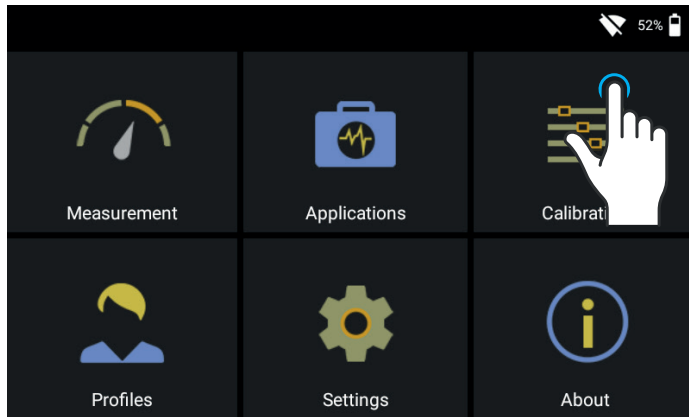

Figure 22: Calibration

In the Calibration sub-menu tap the "Zero Offset" icon. Follow the instructions on the screen and tap Start. After successful calibration a confirmation appears. The device is now ready for use.

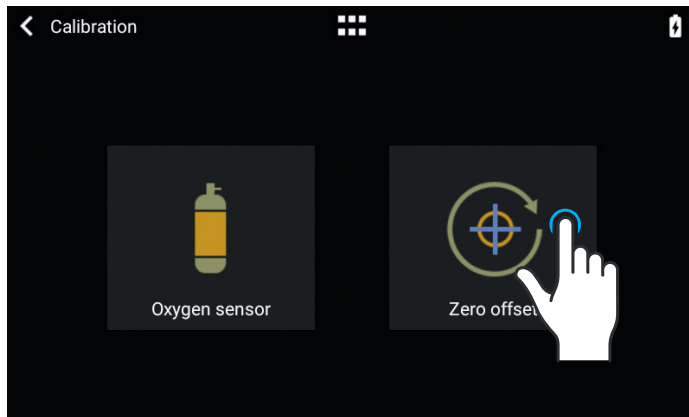

Figure 23: Zero offset



When you have switched on the device, individual displays may deviate slightly from the zero point until operating temperature has been reached. Zero calibration should never be performed with the device cold. Warming-up time is approx. 10 minutes.

## 7.2 Oxygen (O<sub>2</sub>) calibration

There are two different methods of calibrating the oxygen cell. The variant in which the oxygen cell is calibrated with air only takes about two minutes. The second variant consists of calibrating the oxygen cell with air and 100% oxygen. This so-called two-point calibration adjusts the oxygen sensor more accurately. Calibration can be called up under Calibration and then Oxygen Sensor. See figure 21.

### 7.2.1 Calibration with air only

Make sure air is flowing through the flow channel at a rate of at least 30L/min. Then press "Start Air Calibration" and follow the instructions on the screen. The entire process takes about two minutes. At the end of the process a message appears confirming that calibration was successful, or an error message appears.

### 7.2.2 Calibration with oxygen and air

In this calibration, the requirement is oxygen (100%) and air at a flow of 30 L/min. In the first step, the sensor is subjected to oxygen calibration. For this purpose connect the device to a gas flow source with an oxygen flow of 30L/min and press "Start Oxygen Calibration". Follow the instructions on the screen. In the second step you must connect air with a gas flow of 30L/min. The entire process takes about four minutes.

## 8 Connecting the device

The measurement setup for CITREX H5 has an impact on flow measurement. To obtain results that are as accurate as possible, comply with the instructions in this section. It is important to ensure that the tubing in the measurement setup does not have any radii, kinks or dents. You are also recommended to always use the inlet pipe and the dust filter.



The measured gases must be free of oil, grease and dust.

### 8.1 General measurement setup

The general measurement setup applies to gas flow measurement. A filter and the inlet pipe must be used. This ensures laminar flow to the flow sensor unit. The filter also prevents dust, oil and grease from contaminating the CITREX H5 measuring instrument and thus prevents discrepancies in measurement results. The measurement setups shown below are dependent on the direction of gas flow being measured.

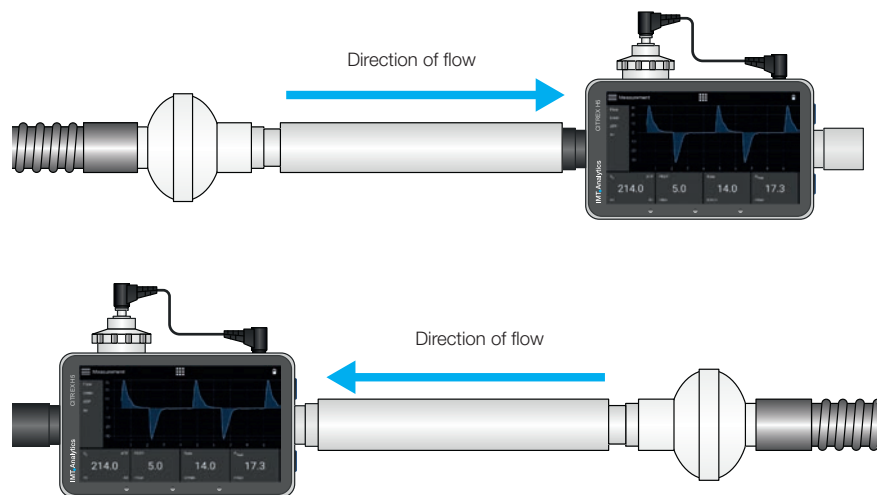

The measured gases must be free of oil, grease and dust. The best measurement results for flow measurements are achieved with the "Adult" trigger setting.

The measurement setups listed below are bad and produce bad measurement results. Kinks, tees and angle pieces must be avoided in the flow channel. They cause turbulence in the gas being measured and hence bad or incorrect measurement results.

**Bad setup:** Kinks, tees, angle pieces at the device inlet



### 8.2 Measurement setup for checking ventilators

CITREX H5 is ideal for checking ventilators. The best measurement results are achieved with the measurement setup shown below. Make sure the test lung is connected to the grey aluminium port of CITREX H5.

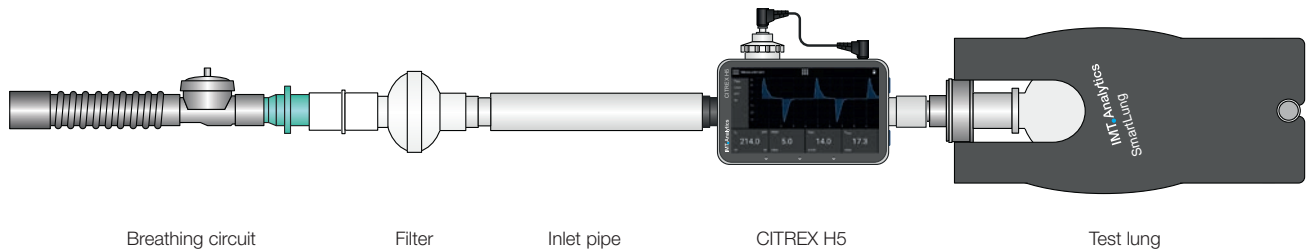

### 8.3 Measurement setup for gases at high pressure

CITREX H5 compensates for the gas pressure during flow measurement. In the flow channel, gas pressures up to 150 mbar are compensated. For gases at higher pressures the high-pressure sensor can be used. For this purpose connect the device outlet to the high-pressure sensor. In the menu "Settings", "Measurement" you must also switch the "Pressure Compensation" setting to "Pressure High".

In the flow channel, pressures up to 150 mbar can be compensated. In conjunction with the high-pressure sensor, pressures up to 300 mbar can be compensated. Pressures in the flow channel above 800 mbar can damage the device.

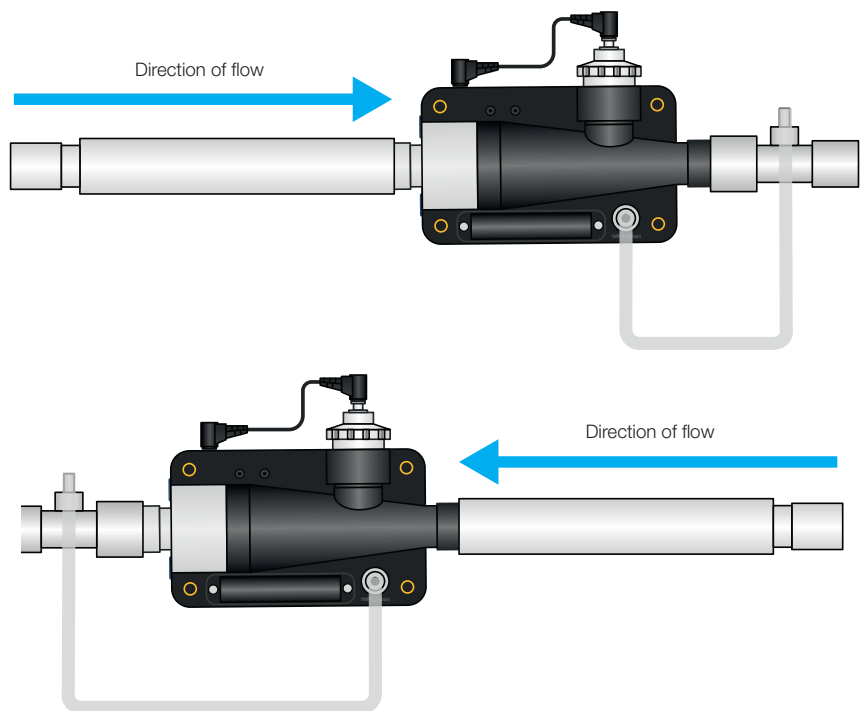

## 9 Profiles

The user has the option of saving different profiles to suit particular requirements.

Profiles can be edited, imported, exported or deleted. In the main menu there is a menu item called "Profiles". This is where all stored profiles are managed.

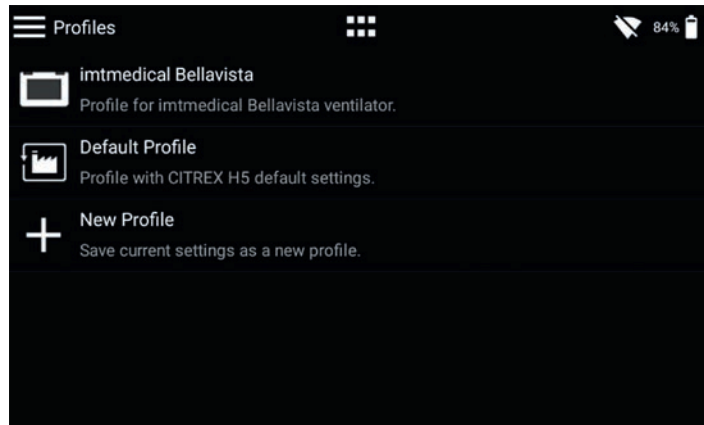

Figure 24: Profile overview

With the current software version you can access edit mode by tapping a certain profile. There you can delete the profile, change the description and the name, and export the profile.

To save the current settings as a profile, tap the context menu icon and then "Save current settings as Profile". There you also have the option of exporting all the profiles or individual ones.

## 10 Configuration tool

### 10.1 PC minimum requirements

Microsoft® Silverlight 5 or higher

Windows x86 or x64 (64-bit mode only supports IE) 1.6 GHz or higher with 512 MB RAM

Macintosh (Intel based) Intel Core Duo 1.83 GHz or higher with 512 MB RAM

Microsoft® Windows® 10, 8.1, 8, Windows Server 2012, 7, 7 SP1, Windows Server 2008 SP2, Windows Server 2008 R2 SP1, Vista

Macintosh OS 10.6 (Intel based), MacOS 10.7–10.11 (Intel based)

Ethernet network connection

Screen resolution 1024 × 768 (1280 × 1024 recommended)

### 10.2 Web server

The Ethernet port on CITREX H5 enables access to the device via a network. The measured real time data can be tracked and analysed on the computer. Settings can also be made on the device via the web browser.

The prerequisite for using the web server is an installed Internet Explorer with Microsoft Silverlight 5.

There are three different setting options to establish a connection between CITREX H5 and a computer. In the "Settings" menu go into the "Device" sub-menu and at the "Ethernet" item select one of the following setting options.

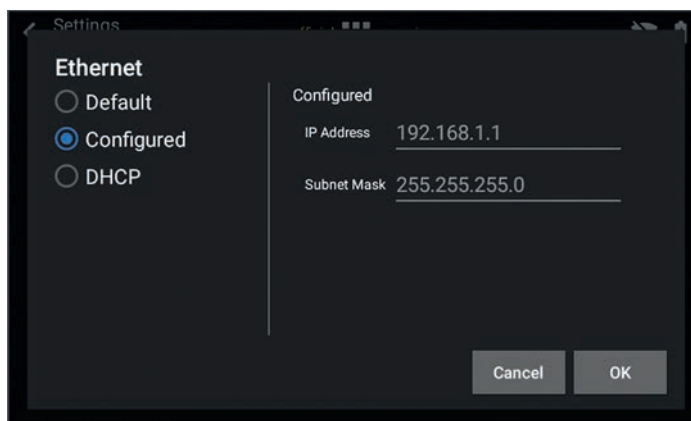

Figure 25: "Ethernet" menu

### 10.2.1 Default

These are default settings that cannot be changed. These settings are recommended in order to establish a direct connection to the computer via an Ethernet cable. The configuration on CITREX H5 is as follows:

IP Address: 192.168.1.1  
 Subnet Mask: 255.255.255.0

To establish a connection, the network settings on the computer must be changed. For this purpose open the network settings of the computer, which are located in the Control Panel. Then open the "Internet Protocol Version 4 (TCP/IPv4)" settings. Enter an IP address between 192.168.1.2 and 192.168.1.255 and subnet mask 255.255.255.0 in the form on the screen. Confirm with "OK".

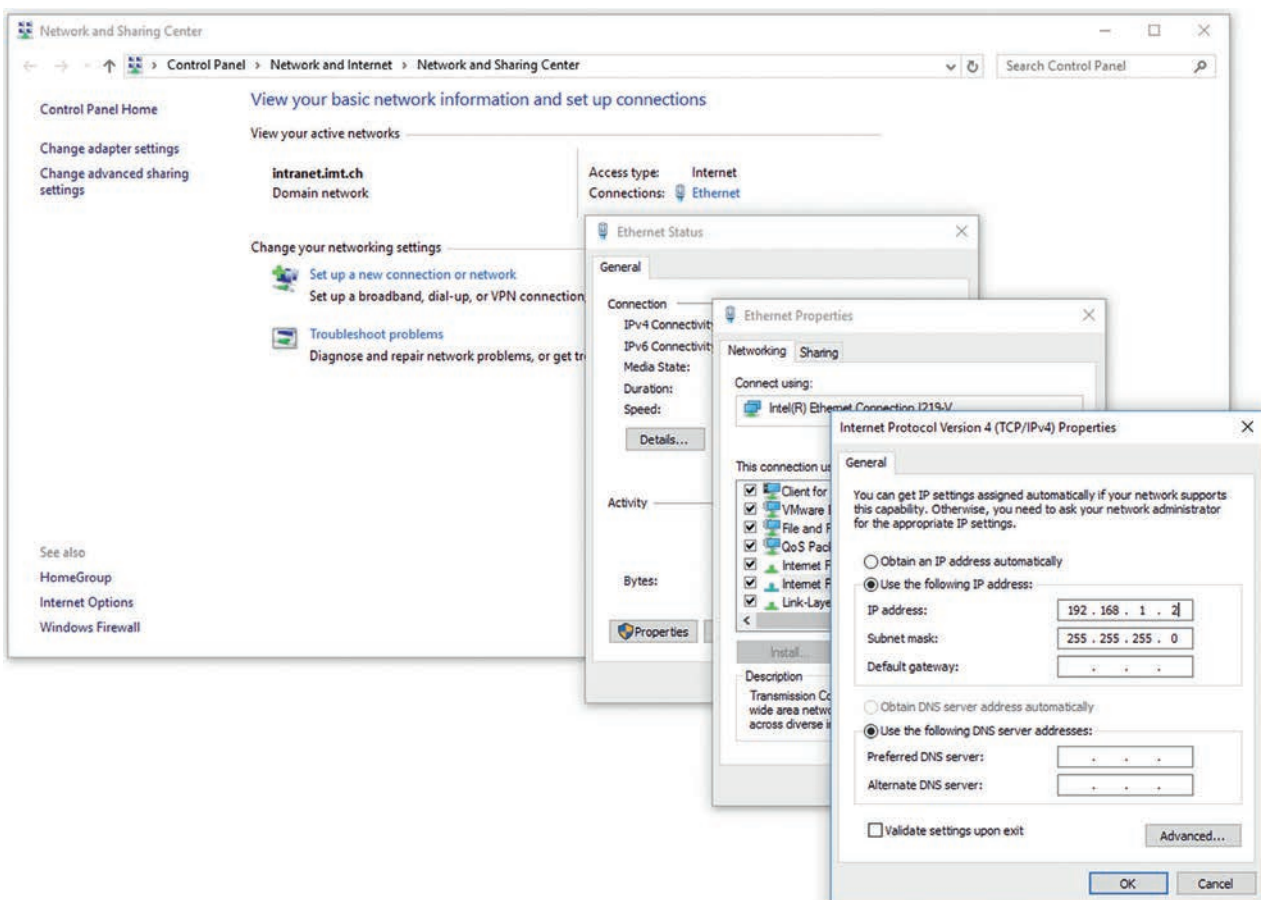

Figure 26: Settings on the computer

Now open Internet Explorer and enter IP address 192.168.1.1 in the address field. The connection is established.



### 10.2.2 Configured

This setting option is suitable for connecting CITREX H5 to a network that does not have a DHCP server. Define an IP address and a subnet mask on CITREX H5. When the settings have been confirmed the device can be connected up to the network and be accessed using the defined IP address via Internet Explorer.

### 10.2.3 DHCP

To connect CITREX H5 to a DHCP server, first connect CITREX H5 to the network. In the "Ethernet" menu select the setting "DHCP" and confirm it with "OK". With the IP address shown on the display it is possible to establish a connection to CITREX H5 via Internet Explorer.

### 10.2.4 Monitoring option

In the "Monitoring" menu item it is possible to access the measurement data of CITREX H5 via the network. Either numerical readings or graphical measurement curves can be selected.

#### Numerical readings

Here it is possible to directly track real-time measurement data on the computer monitor. Both current readings and a minimum, a maximum and a mean are calculated for each reading. Statistical analysis can be restarted by pressing the "Reset" button. There is also the option of exporting the readings currently being displayed. To do this, press the "Export" button: an Explorer window opens in which you can select the storage location and the storage type. There are XML files (\*.xml) and CSV files (\*.csv) available for selection.

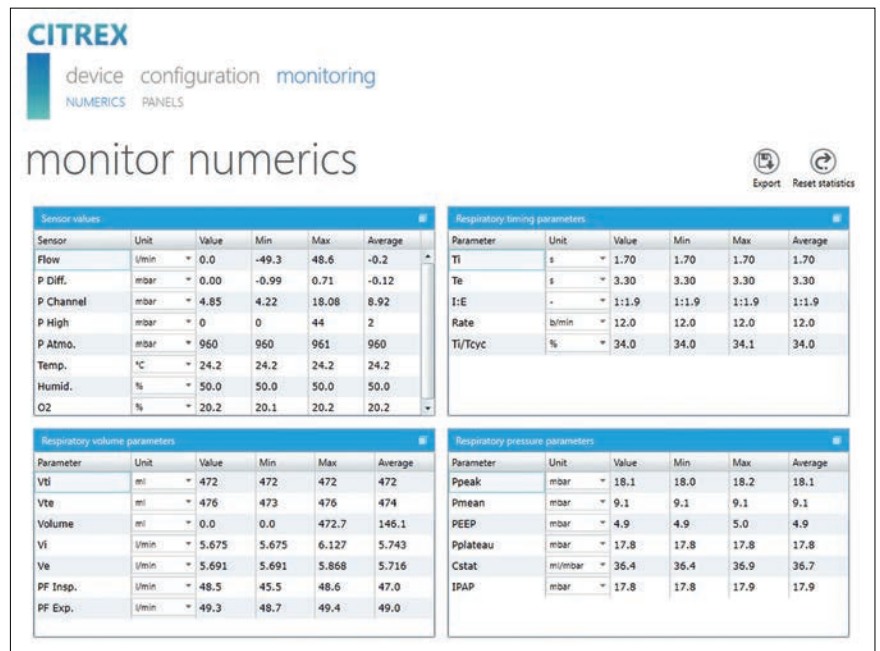

Figure 27: Numerical values with statistics

### Graphical readings

Here it is possible to directly track real-time curves on the computer monitor. Select the required reading using the pull-down menu. By pressing the "Run" button it is also possible to record readings for 300 seconds. Recording can be terminated by pressing the "Freeze" button. If you have recorded a measurement, you can move the slider into the desired measuring time in order to analyse the period here. Incidentally, it is not only the displayed measurement curves that are recorded; all the readings available for selection are also recorded. There is also the option of exporting the measurement curves currently being displayed. To do this, press the "Export" button: an Explorer window opens in which you can select the storage location. The curves can be saved in the form of a PNG file.

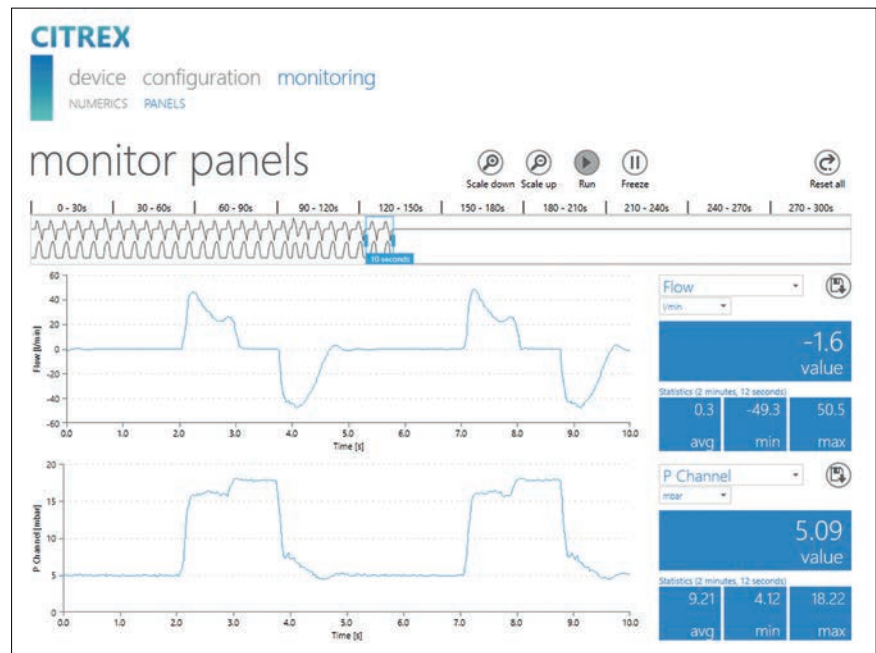

Figure 28: Measurement curves with statistics

## 11 Reading measurement data



The files on the microSD card must not be renamed or deleted under any circumstances.



Measurement data can be read via the microSD card, via the Analog OUT interface or via the RS-232 interface. For information about using these interfaces please contact your dealer or IMT Analytics directly.

### 11.1 Reading the data

The data can be read directly from the SD card. For this purpose you must disconnect the SD card from CITREX H5 by pressing the SD card once. It is possible to connect the card to your computer directly using an SD card reader.

The memory card of CITREX H5 contains the following data and folders.

Folder or file	Description
DATA	In this directory you will find the readings that have been saved.
LOGS	CITREX H5 continuously records information about its functions and saves it in the form of log files. This data is only used for remedying malfunctions and resolving issues.
*.CFG, *.SCR, *.TRG files	CFG, SCR and TRG files are required by CITREX to activate internal processes.
Formatter\SetupReportFormatter.bat	This batch file is required to format saved data in an Excel file.
Formatter\AboutReportFormatter.txt	This TXT file describes the procedure for formatting saved data in an Excel file.
Formatter\ReportFormatter.xlsb	This is the actual Excel file template in which the saved data is formatted.
ClientBin\ConfigurationWeb.xap	This directory is required for the configuration tool.
Clientaccesspolicy.xml	This file is required for the configuration tool.
index.html	This file is required for the configuration tool.
USB-Driver\usb_cdc_ser.inf	Driver for USB device recognition.

Table 6: Folder structure of CITREX H5

### 11.2 Cloud service

By linking CITREX H5 to your Dropbox account it is possible to upload test reports and profiles to the Dropbox folder. For this purpose CITREX H5 must be connected to the WLAN. Under the menu item "Sign In" the Dropbox account details must be entered. New files are automatically copied to Dropbox with the "Upload" switch.

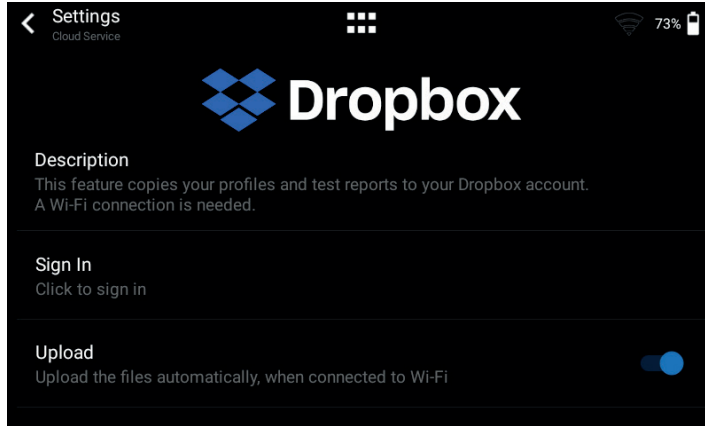

Figure 29: Dropbox

## 12 Servicing and care

Careful servicing in compliance with the instructions is essential for ensuring that CITREX H5 operates safely and efficiently. Only components recommended by the manufacturer may be used.



It is absolutely essential to comply with the guidelines and servicing instructions issued by the various manufacturers.



The servicing operations listed below may only be performed by persons who are familiar with CITREX H5. All further repair work may only be performed by authorised trained professionals. Please also observe the information issued by the various manufacturers.

### 12.1 Preventive cleaning and servicing operations

To ensure that your device operates with precision and reliability for as long as possible, it is essential to perform the following servicing routines regularly.

#### 12.1.1 During operation

Use of the filter included and the inlet pipe. Make sure the device is only used inside a building.

#### 12.1.2 Every 4 weeks

Check the bacterial filter for soiling. For this purpose the inlet and outlet of the filter must be connected to the differential pressure port using two tees. In this way the pressure drop above the filter can be measured. The pressure drop must not exceed a value of 2 mbar at a flow of 60 L/min. Otherwise the filter must be replaced.

#### 12.1.3 Every 12 months

Factory calibration and servicing to ensure reliable measurement; it may only be performed by IMT Analytics or an authorised partner.

To have CITREX H5 calibrated at the manufacturer's, IMT Analytics, visit the website [www.imtanalytics.com/easyca](http://www.imtanalytics.com/easyca)

The EasyCal service makes it possible for users to have CITREX H5 calibrated and adjusted quickly and easily. The annual servicing procedure is also performed.

## 13 Accessories and spare parts

On the website [www.imtanalytics.com](http://www.imtanalytics.com) you will find the spare parts and other products from IMT Analytics.

### Ordering address:

IMT Analytics AG  
Gewerbstrasse 8  
CH-9470 Buchs, Switzerland

Tel: +41 (0) 81 750 67 10  
Email: [sales@imtanalytics.com](mailto:sales@imtanalytics.com)

### 13.1 Accessories table

#### Options

304.587.000	Warranty extension (plus 2 years) for CITREX H5
000.000.024	ISO 17025 Recalibration and Servicing of CITREX H5
000.000.015	Recalibration and servicing of CITREX H5
000.000.016	Receiving inspection of CITREX H5
304.592.000	Triple recalibration and servicing package for CITREX H5

#### Accessories and consumables

300.548.000	Adapter set
301.997.000	Car adapter for CITREX
302.077.000	Laminar inlet pipe
304.161.000	Black protective pouch for CITREX
304.161.001	Red protective pouch for CITREX
304.161.002	Blue protective pouch for CITREX
500.030.000	High-pressure adapter DISS O <sub>2</sub>
500.030.002	High-pressure adapter DISS Air
301.851.000	MicroSD memory card
302.075.000	RS-232 interface cable
301.672.000	Analog output terminal connector
301.655.000	Blind plug for oxygen port (rubber)
302.178.000	Blind plug for oxygen port (solid)
301.624.000	Oxygen sensor with mono jack
302.531.000	Bacterial filter RT019
304.714.000	CITREX stand

#### Spare parts

304.593.000	Carrying case for CITREX H5
301.625.000	Battery for CITREX
301.563.000	Network cable
304.582.000	USB adapter for CITREX H5
301.673.000	USB cable for CITREX
301.653.000	Oxygen sensor cable
304.578.000	Power supply plug for CITREX
302.780.000	Flow channel protective cap

## 14 Disposal

Disposal of the device is the operator's responsibility. The device can ...

- be delivered, carriage free and duty paid, to the manufacturer for disposal.
- be handed over to a licensed private or public collection company.
- be professionally broken down into its constituent parts by the operator and be recycled or disposed of in accordance with regulations.

In the case of self-disposal the disposal regulations are country-specific and are contained in relevant laws and ordinances. These codes of conduct must be obtained from the authorities responsible.

In this context, wastes must be recycled or destroyed ...

- without endangering human health.
- without using processes or methods that harm the environment, especially water, air, soil, animals and plants.
- without causing noise or odour nuisances.
- without having a detrimental effect on the surroundings or landscape.

## 15 Directives and approvals

- CE
- CAN/CSA-C22.2 No. 61010-1-12
- UL Std. No. 61010-1 (3rd Edition)
- IEC 61010-1 2010
- IEC 61326-1 2012
- ETSI EN 301 489-17 V3.1.0
- FCC Part 15, Subpart B, Digital Devices, Emission Class B

### **CE Declaration of Conformity**

#### **2014/35/EU (LVD)**

DIRECTIVE 2014/35/EU OF THE EUROPEAN PARLIAMENT AND OF THE COUNCIL of 26 February 2014 on the harmonisation of the laws of the Member States relating to the making available on the market of electrical equipment designed for use within certain voltage limits tested according to EN61010-1:2010

#### **2014/30/EU (EMC)**

DIRECTIVE 2014/30/EU OF THE EUROPEAN PARLIAMENT AND OF THE COUNCIL of 26 February 2014 on the harmonisation of the laws of the Member States relating to electromagnetic compatibility tested according to EN61326-1:2013

#### **2014/53/EU (RED)**

DIRECTIVE 2014/53/EU OF THE EUROPEAN PARLIAMENT AND OF THE COUNCIL of 16 April 2014 on the harmonisation of the laws of the Member States relating to the making available on the market of radio equipment and tested according to ETSI EN 301 489-17 V3.1.0



## 16 Specifications

### 16.1 Measurement parameters

Flow and pressure measurement	Measuring range	Accuracy
<b>Air and N<sub>2</sub></b>		
Flow measurement	± 300 sL/min <sup>***</sup>	± 1.9% * or ± 0.1 sL/min <sup>**</sup>
Temperature compensated	Yes	
Ambient pressure compensated	Yes	
Channel pressure compensated	Yes	- 50 – 600 mbar
<b>O<sub>2</sub> / air mixtures</b>		
Flow measurement	± 300 sL/min <sup>***</sup>	± 1.9% * or ± 0.1 sL/min <sup>**</sup>
Temperature compensated	Yes	
Ambient pressure compensated	Yes	
Channel pressure compensated	Yes	- 50 – 600 mbar
<b>CO<sub>2</sub></b>		
Flow measurement	± 140 sL/min <sup>***</sup>	3% * or ± 0.1 sL/min <sup>**</sup>
Temperature compensated	Yes	25 – 30°C
Ambient pressure compensated	Yes	
Channel pressure compensated	Yes	- 50 – 600 mbar
<b>Heliox (21% O<sub>2</sub>/79% He)</b>		
Flow measurement	± 300 sL/min <sup>***</sup>	± 4% * or ± 0.3 sL/min <sup>**</sup>
Temperature compensated	Yes	25 – 30°C
Ambient pressure compensated	Yes	
Channel pressure compensated	Yes	- 50 – 600 mbar
<b>N<sub>2</sub>O / O<sub>2</sub> mixtures</b>		
Flow measurement	± 80 sL/min <sup>***</sup>	± 4% * or ± 0.3 sL/min <sup>**</sup>
Temperature compensated	Yes	25 – 30°C
Ambient pressure compensated	Yes	
Channel pressure compensated	Yes	- 50 – 600 mbar
<b>Pressure</b>		
High	0 – 10 bar	± 1% * or ± 10 mbar <sup>**</sup>
Difference	± 200 mbar	± 0.75% * or ± 0.1 mbar <sup>**</sup>
In flow channel	- 50 – 150 mbar	± 0.75% * or ± 0.1 mbar <sup>**</sup>
Barometer	500 – 1150 mbar	± 1% * or ± 5 mbar <sup>**</sup>

Additional readings	Measuring range	Accuracy
Oxygen concentration (pressure compensated $\leq$ 150 mbar)	0–100 %	$\pm 1\% \text{O}_2^{**}$
Gas temperature****	0–50°C	$\pm 1.75\%^*$ or $\pm 0.5^\circ\text{C}^{**}$
Gas type	Air, Air/O <sub>2</sub> , N <sub>2</sub> O/O <sub>2</sub> , Heliox (21% O <sub>2</sub> ), N <sub>2</sub> , CO <sub>2</sub>	
Gas standard	ATP, ATPD, ATPS, AP21, STP, STPH, BTPS, BTPS-A, BTPD, BTPD-A, 0/1013, 20/981, 15/1013, 25/991, 20/1013, NTPD, NTPS	

**Units of measurement**

Flow	L/min, L/s, cfm, mL/min, mL/s	
Pressure	bar, mbar, cmH <sub>2</sub> O, inH <sub>2</sub> O, Torr, inHg, hPa, kPa, mmHg, PSI	

It is the larger tolerance that applies: \* Tolerance in relation to the reading \*\* Absolute tolerance

\*\*\* In this User Manual the unit sL/min is based on ambient conditions of 0°C and 1013.25 mbar (DIN1343)

\*\*\*\* CITREX H5 measures gas temperature inside the measurement channel. While CITREX H5 is warming up, the temperature of the measurement channel, and hence also the temperature of the gas inside the measurement channel, rises at the same time. The measurement channel volume is relatively small, even for relatively high volumetric flows (e.g. PIF @ 60L/min). If the temperature of the gas on entering CITREX H5 is compared with gas temperature in the measurement channel, it becomes evident that the temperature in the measurement channel is higher. Therefore the temperature of the gas entering the CITREX H5 measurement channel should not be expected to equal the temperature displayed on the screen because the temperature displayed is measured inside the CITREX H5 measurement channel.

Ventilation parameters		Measuring range	Accuracy
Rate	Breaths/min	1 – 1000 breaths/min	± 1 breath or ± 2.5% **
Time	T <sub>i</sub> , T <sub>e</sub>	0.05 – 60s	± 0.02s
Ratio	I:E	1:300 – 300:1	± 2.5 % *
	T <sub>i</sub> /T <sub>cyc</sub>	0 – 100 %	± 5 % *
Tidal volume	V <sub>ti</sub> , V <sub>te</sub>	± 10sL	± 2%* or ± 0.20mL (> 6sL/min)**
Peak flow	PF <sub>Insp</sub> /PF <sub>Exp</sub>	± 300 sL/min	± 1.9%* or ± 0.1 sL/min**
Pressure	P <sub>Peak</sub> , P <sub>Mean</sub> , PEEP, P <sub>Plateau</sub> , IPAP	0 – 150mbar	± 0.75%* or ± 0.1 mbar**
Compliance	C <sub>Stat</sub>	0 – 1000mL/mbar	± 3%* or ± 1 mL/mbar**
Trigger	Adult, Paediatric, HFO flow and volume		

#### General information

Screen	4.3" multi-touch screen with 800 × 480 pixels
Real-time curves	Flow, pressure, volume, temperature, oxygen, ventilation parameters
Interfaces	RS-232, USB, Ethernet, CAN, Analog Out, TTL, Wi-Fi
AC input	100 – 240 VAC (50/60 Hz)
Battery operation	5 hours
Dimensions (W × D × H)	11.4 × 7 × 7.3 cm
Weight	0.52 kg
Calibration interval	Once a year
Memory card	Yes

#### Operating data

Ambient temperature	15 – 40°C (59 – 104°F)
Air humidity	10 – 90% RH
Ambient pressure	783 – 1150mbar
Storage and transport conditions	-10 – 60°C (14 – 140°F) at 5 – 95% RH
Degree of soiling	Degree of soiling 2, to IEC 61010-1

It is the larger tolerance that applies: \* Tolerance in relation to the reading \*\* Absolute tolerance

\*\*\* In this User Manual the unit sL/min is based on ambient conditions of 0°C and 1013.25 mbar (DIN1343)

### 16.2 Interface definition

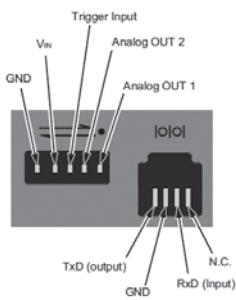

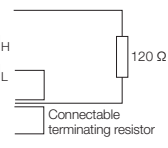
Interface	Pin assignment	Range
Analog OUT	Pin 1: Analog OUT 1 Pin 2: Analog OUT 2 Pin 3: Trigger Input Pin 4: V <sub>IN</sub> Pin 5: GND	0–5 VDC ± 1.8%, load ≥ 5 kΩ 0–5 VDC ± 1.8%, load ≥ 5 kΩ 5–24 VDC 12 VDC ± 20%–24 VDC ± 20%
RS-232	Pin 1: NC Pin 2: RxD (Input) Pin 3: TxD (Output) Pin 4: GND	
CAN	Pin 1: VIN Pin 2: CAN <sub>H</sub> Pin 3: CAN <sub>L</sub> Pin 4:  Pin 5: Pin 6: GND	12 VDC ± 20%–24 VDC ± 20%

### 16.3 Gas type

The type of gas measured must agree with the setting on CITREX H5. Please select the correct gas type in the settings.

The following gas types are available for selection:

- Air 100%
- Air/O<sub>2</sub>-Man. Air/oxygen mixture according to manual input; the default is 100% O<sub>2</sub>
- Air/O<sub>2</sub>-Auto. Air/oxygen mixture according to sensor measurement of internal oxygen cell
- N<sub>2</sub>O/O<sub>2</sub>-Man. Nitrous oxide / oxygen mixture according to manual input; the default is 100% O<sub>2</sub>
- Heliox 21% O<sub>2</sub>/79% He
- N<sub>2</sub> 100%
- CO<sub>2</sub> 100%

Standard conditions are understood to mean defined conditions for pressure, temperature and, in some cases, humidity, which constitute the basis for converting the flow actually measured. Therefore it is essential to check which standard condition the value displayed will relate to.

The standard currently set is indicated on the numerical and graphical display.



A gas type that has not been selected properly and a gas standard that has not been selected properly can lead to measuring errors of up to 20%.

**16.4 Power supply**

Input voltage of the power supply unit	100–240 VAC, 50–60 Hz
Supply voltage	5 VDC
Power input	2.5–6 W

**16.5 Battery operation**

Operating time in battery operation	5 hours*
Charging the battery	A complete charging process takes 5 to 8 h, depending on which connection port is used for charging. The service life of the battery is extended if the battery is charged completely only after a prompt by the device

\* This operating time is reached in non-networked operation (i.e. the interfaces are not in use or they are switched off)

## 17 Appendix

### 17.1 Principle of flow measurement

Flow in the flow channel is determined by differential pressure measurement. To build up differential pressure a linear flow element is used to provide flow resistance.

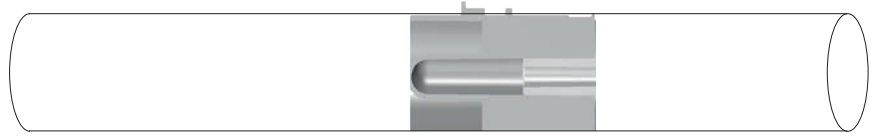

$$\Delta p = c_1 \times \eta \times Q + c_2 \times \rho \times Q^2$$

$\eta$ : dynamic viscosity of the gas [Pa s]

$\rho$ : gas density [kg/m<sup>3</sup>]

$c_1, c_2$ : device-specific constants (channel geometry)

#### Dynamic viscosity

- The viscosity of the medium is its resistance to flow and shear.
- Viscosity is extremely dependent on temperature.
- The viscosity of a medium is slightly dependent on the pressure and moisture content of the medium.

#### Density

- Density is the unit for the mass per unit volume of the medium.
- Viscosity is extremely dependent on temperature.
- The viscosity of a medium is slightly dependent on the pressure and moisture content of the medium.

17.2 Measurement parameters and units

Pressure readings	Measurement parameter	Designation	Units of measurement
	Ambient pressure Pressure high Pressure in flow channel high Differential pressure	$P_{Atmo}$ $P_{High}$ $P_{Channel}$ $P_{Diff}$	mbar, bar, inH <sub>2</sub> O, cmH <sub>2</sub> O, psi, Torr, inHg, mmHg, hPa, kPa
Flow readings	Measurement parameter	Designation	Units of measurement
	Flow	Flow	L/min, mL/min, cfm, L/s, mL/s
Meteorological readings	Measurement parameter	Designation	Units of measurement
	Temperature Oxygen content Volume	Temp. $O_2$ Volume	°C, K, °F % mL, L, cf
Gas concentrations	Measurement parameter	Designation	Units of measurement
	Gas concentration Partial pressure	Gas concentration Partial pressure	% mbar, bar, inH <sub>2</sub> O, cmH <sub>2</sub> O, psi, Torr, inHg, mmHg, hPa, kPa
Ventilation parameters	Measurement parameter	Designation	Units of measurement
	Positive end-expiratory pressure Mean pressure Inspiratory positive airway pressure Maximum pressure Plateau pressure  Expiratory minute volume Inspiratory minute volume Inspiratory peak flow Expiratory peak flow  Expiratory volume Inspiratory volume Ventilation rate Inspiratory/expiratory ratio Expiratory time Inspiratory time Compliance	$PEEP$ $P_{Mean}$ IPAP $P_{Peak}$ $P_{Plateau}$  $V_e$ $V_i$ $PF_{Insp}$ $PF_{Exp}$  $V_{te}$ $V_{ti}$ Rate I:E $T_e$ $T_i$ $C_{Stat}$	mbar, bar, inH <sub>2</sub> O, cmH <sub>2</sub> O, psi, Torr, inHg, mmHg, hPa, kPa  L/min, mL/min, cfm, L/s, mL/s  mL, L, cf mL, L, cf Breaths/min  s s mL/mbar, L/mbar, mL/cmH <sub>2</sub> O, mL/cmH <sub>2</sub> O

### 17.3 Gas standards for flow and volume readings

CITREX H5 converts the flow and volume readings measured in the device to match the conditions of the standard selected. The following gas standards are supported by CITREX H5.

Gas standard	Abbreviation	Pressure	Temperature	Relative humidity
Ambient Temperature and Pressure	ATP	Current ambient pressure	Current gas temperature	Current gas humidity
Ambient Temperature and Pressure Dry	ATPD	Current ambient pressure	Current gas temperature	0%
Ambient Temperature and Pressure Saturated	ATPS	Current ambient pressure	Current gas temperature	100%
Ambient Pressure at 21 °C	AP21	Current ambient pressure	21.0 °C (70 °F)	Current gas humidity
Standard Conditions USA	STP	1013.25 mbar (760 mmHg)	21.0 °C (70 °F)	0%
Standard Conditions USA Humid	STPH	1013.25 mbar (760 mmHg)	21.0 °C (70 °F)	Current gas humidity
Body Temperature and Pressure, Saturated	BTPS	Current ambient pressure + channel pressure	37.0 °C (99 °F)	100%
Body Temperature and (Ambient) Pressure Saturated according to ISO 80601-2-12:2011	BTPS-A	Current ambient pressure	37.0 °C (99 °F)	100%
Body Temperature and Pressure Dry	BTPD	Current ambient pressure + channel pressure	37.0 °C (99 °F)	0%
Body Temperature And (Ambient) Pressure Dry	BTPD-A	Current ambient pressure	37.0 °C (99 °F)	0%
Standard Conditions to DIN1343	0/1013	1013.25 mbar (760 mmHg)	0.0 °C (32 °F)	0%
Standard Conditions to ISO 1-1975 (DIN 102)	20/981	981 mbar (736 mmHg)	20.0 °C (68 °F)	0%
API Standard Conditions	15/1013	1013.25 mbar (14.7 psia)	15.0 °C (60 °F)	0%
Cummings Standard	25/991	991 mbar (500 ft altitude)	25.0 °C (77 °F)	0%
20 °C/1013 mbar	20/1013	1013.25 mbar (760 mmHg)	20.0 °C (68 °F)	0%
Normal Temperature and Pressure	NTPD	1013.25 mbar (760 mmHg)	20.0 °C (68 °F)	0%
Normal Temperature and Pressure, Saturated	NTPS	1013.25 mbar (760 mmHg)	20.0 °C (68 °F)	100%



## 17.4 Conversion factors

Value	Equivalent		
1 mbar	0.001	bar	
	100	Pa	
	1	hPa	
	0.1	kPa	
	0.75006	torr	(760 torr = 1 atm.)
	0.75006	mmHg	(at 0 °C)
	0.02953	inHg	(at 0 °C)
	1.01974	cmH <sub>2</sub> O	(at 4 °C)
	0.40147	inH <sub>2</sub> O	(at 4 °C)
	0.01450	psi, psia	
1 bar	1000	mbar	
	0.1	Pa	
	1000	hPa	
	100	kPa	
	750.06	torr	(760 torr = 1 atm.)
	750.06	mmHg	(at 0 °C)
	29.53	inHg	(at 0 °C)
	1019.74	cmH <sub>2</sub> O	(at 4 °C)
	401.47	inH <sub>2</sub> O	(at 4 °C)
	14.50	psi, psia	

**17.5 List of tables**

Table 1: Symbol explanation	8
Table 2: Scope of delivery	9
Table 3: Description of electrical interfaces	16
Table 4: Gestures	20
Table 5: Menu items	21
Table 6: Folder structure of CITREX H5	35

**17.6 List of figures**

Figure 1: Power supply	10
Figure 2: Flow channel	11
Figure 3: Differential pressure connector	12
Figure 4: High-pressure connector	13
Figure 5: Oxygen sensor holder	14
Figure 6: Protective cap	14
Figure 7: Screwing in the oxygen sensor	15
Figure 8: Oxygen sensor cable	15
Figure 9: Electrical interfaces	16
Figure 10: Wi-Fi	17
Figure 11: Change battery	17
Figure 12: Shutdown menu	18
Figure 13: Start screen	18
Figure 14: User controls	19
Figure 15: Main menu	21
Figure 16: Settings	22
Figure 17: Numerical readings	23
Figure 18: Graphical readings	23
Figure 19: Software update	24
Figure 20: Applications	25
Figure 21: Reports	25
Figure 22: Calibration	26
Figure 23: Zero offset	26
Figure 24: Profile overview	30
Figure 25: "Ethernet" menu	31
Figure 26: Settings on the computer	32
Figure 27: Numerical values with statistics	33
Figure 28: Measurement curves with statistics	34
Figure 29: Dropbox	36

## 17.7 Index

**A**

Accessories 38  
 Analog OUT 16  
 Angle pieces 28  
 Approvals 40

**B**

Battery 10, 17, 19, 24, 45  
 Battery depletion 10  
 Battery operation 45

**C**

Calibration 26, 27  
 Calibration with air only 27  
 Calibration with oxygen and air 27  
 CAN 16  
 CAN interface 10  
 Care 37  
 Change battery 17  
 Charging the battery 45  
 Cleaning 37  
 Cloud service 36  
 Configuration tool 31  
 Connecting the device 28  
 Conversion factors 49

**D**

Default 32  
 DHCP 33  
 Differential pressure 12  
 Directives 40  
 Disposal 39  
 DISS adapter 13  
 Dropbox 36  
 Dynamic viscosity 46

**E**

Electrical interfaces 16  
 Ethernet 16

**F**

Firmware 5  
 Flow and volume readings 48  
 Flow channel 11  
 Flow measurement 46

**G**

Gas concentrations 47  
 Gas standard 48  
 Gas standards 48  
 Graphical readings 23, 34

**H**

High pressure 13

**I**

Installing the oxygen sensor 14  
 Intended use 6  
 Interface definition 44

**M**

Measurement data 35  
 Measurement parameters 41, 47  
 Measurements 6  
 Measurement setup 28  
 Mechanical connectors 11  
 Meteorological readings 47  
 MicroSD 16  
 Monitoring option 33  
 Multi-touch 20

**N**

Notes 7  
 Numerical readings 23, 33

**O**

O<sub>2</sub> 27  
 O<sub>2</sub> interface 16  
 Operating time 45  
 Operation 18  
 Options 38  
 Oxygen 27  
 Oxygen sensor 14

**P**

PC minimum requirements 31  
 Personnel 7  
 Power supply 10, 45  
 Pressure readings 47  
 Profiles 30

**R**

Reading the data 35  
 Remove battery 17  
 RS-232 16

**S**

Safety instructions 7  
 Screen 20  
 Screen lock 24  
 Service life 7  
 Servicing 37  
 Servicing operations 37  
 Settings 22  
 Software update 24  
 Spare parts 38  
 Specifications 41  
 Start screen 18, 21  
 Start-up 9  
 Switching the device on/off 18  
 Symbol explanation 8

### T

Tees [28](#)

### U

Units [47](#)

USB-Host [16](#)

USB port [16](#)

User control gestures [20](#)

User controls [19](#)

### V

Ventilation parameters [6](#)

Versions [5](#)

### W

Web server [31](#)

Wi-Fi [17](#), [24](#)

### Z

Zero offset [26](#)

Zero point [26](#)



# IMT.Analytics

IMT Analytics AG . Gewerbestrasse 8 . 9470 Buchs . Switzerland  
T +41 81 750 67 10 . [www.imtanalytics.com](http://www.imtanalytics.com)